

Product Data Sheet



LKX-SPO 150XK

EAN 4047526016777

ID 16774

Stainless steel heavy duty swivel castor with top plate fitting, Heavy duty nylon wheel

Bracket:

Made of heavy pressed high-quality, chromium-nickel stainless steel (Material No. 1.4301/AISI 304), with double ball bearing in the swivel head, strong central kingpin, swivel head seals. The special Blickle dynamic riveting process of the swivel head results in minimal swivel head play and smooth rolling characteristics with an increased service life achieved by the work hardening of the ball race grooves. All parts incl. axle material are corrosion-resistant. Bolted wheel axle. Vibration-ground finished.

Wheels:

Made of high-quality, impact-resistant nylon, very rugged, heavy wheel design, very low rolling and swivelling resistance, smooth running performance on even floors, very high abrasion resistance.

Tread colours: natural white

Wheel centre/rim: - Wheel centre colour: natural white



Rolling resistance

■■■■■ Excellent

Operating noise

■■□□□ Satisfactory













Floor surface preservation

■■□□□ Satisfactory

Product Data Sheet



Technical data

Plate size		140 x 110
Bolt hole spacing		105 x 75-80
Bolt hole Ø		11
Wheel Ø		150 mm (D)
Wheel width		50 mm (T2)
Load capacity		800 kg
Total height		197 mm (H)
Offset swivel castor		63 mm
unit weight		2,8 kg
Temperature resistance to		-25 ° C
Temperature resistance to		80 ° C
tread and tyre hardness		70° Shore D
Bearing type		Ball bearing

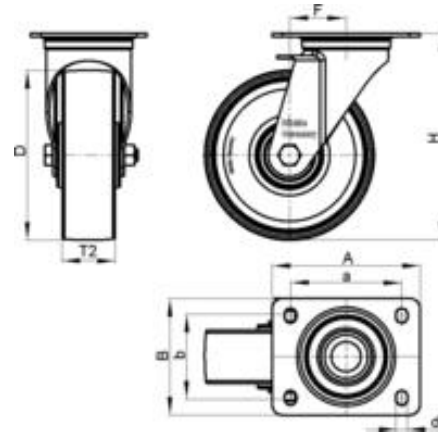

Product Data Sheet



Variants



LKX-SPO 150XK-FI

Stainless steel heavy duty swivel castor with top plate fitting and 'stop-fix' brake, Heavy duty nylon wheel



LKX-SPO 150XK-ST

Stainless steel heavy duty swivel castor with top plate fitting and 'stop-top' brake, Heavy duty nylon wheel