

Product Data Sheet



LK-ALTH 125K-3

EAN 4047526265793

ID 265793

Pressed steel swivel castor, medium heavy duty brackets, with top plate fitting, Heavy duty wheel with Blickle Extrathane® polyurethane tread, with aluminium wheel centre

Bracket:

Made of heavy pressed steel, swivel bracket with double ball bearing in the swivel head, swivel head seals. The special Blickle dynamic riveting process of the swivel head results in minimal swivel head play and smooth rolling characteristics with an increased service life achieved by the work hardening of the ball race grooves. Bolted wheel axle. Zinc-plated, blue-passivated, Cr6-free.

Wheels:

Made of high-quality, reaction-injected polyurethane-elastomer Blickle Extrathane®, low-noise operation, low rolling resistance, good floor preservation, very high abrasion resistance, high cut and tear propagation resistance, very good chemical connection with the wheel centre.

Tread colours: light brown

Wheel centre/rim: Made of die-cast aluminium. Casted tread.

Wheel centre colour: silver grey



Rolling resistance

■■■■□ Very good

Operating noise

■■■■□ Good











Floor surface preservation

■■■■□ Good

Product Data Sheet



Technical data

Plate size		140 x 110
Bolt hole spacing		105 x 75-80
Bolt hole Ø		11
Wheel Ø		125 mm (D)
Wheel width		40 mm (T2)
Load capacity		350 kg
Total height		155 mm (H)
Offset swivel castor		48 mm
unit weight		1,6 kg
Temperature resistance to		-25 ° C
Temperature resistance to		70 ° C
tread and tyre hardness		92° Shore A
Bearing type		Ball bearing

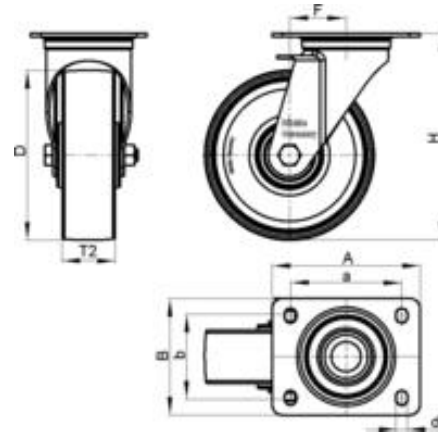

Product Data Sheet



Variants



LK-ALTH 125K-3-AS

Pressed steel swivel castor, medium heavy duty brackets, with top plate fitting, Heavy duty wheel with Blickle Extrathane® polyurethane tread, with aluminium wheel centre



LK-ALTH 125K-3-CS11

Pressed steel swivel castor, medium heavy duty brackets, with top plate fitting and central brake 'central-stop', Heavy duty wheel with Blickle Extrathane® polyurethane tread, with aluminium wheel centre



LK-ALTH 125K-3-CS11-AS

Pressed steel swivel castor, medium heavy duty brackets, with top plate fitting and central brake 'central-stop', Heavy duty wheel with Blickle Extrathane® polyurethane tread, with aluminium wheel centre



LK-ALTH 125K-3-FI

Pressed steel swivel castor, medium heavy duty brackets, with top plate fitting and 'stop-fix' brake, Heavy duty wheel with Blickle Extrathane® polyurethane tread, with aluminium wheel centre



LK-ALTH 125K-3-FI-AS

Pressed steel swivel castor, medium heavy duty brackets, with top plate fitting and 'stop-fix' brake, Heavy duty wheel with Blickle Extrathane® polyurethane tread, with aluminium wheel centre

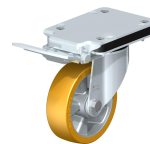

LK-ALTH 125K-3-IS

Pressed steel swivel castor, medium heavy duty brackets, with top plate fitting and 'ideal-stop' brake, Heavy duty wheel with Blickle Extrathane® polyurethane tread, with aluminium wheel centre



LK-ALTH 125K-3-IS-AS

Pressed steel swivel castor, medium heavy duty brackets, with top plate fitting and 'ideal-stop' brake, Heavy duty wheel with Blickle Extrathane® polyurethane tread, with aluminium wheel centre



LK-ALTH 125K-3-ST

Pressed steel swivel castor, medium heavy duty brackets, with top plate fitting and 'stop-top' brake, Heavy duty wheel with Blickle Extrathane® polyurethane tread, with aluminium wheel centre



LK-ALTH 125K-3-ST-AS

Pressed steel swivel castor, medium heavy duty brackets, with top plate fitting and 'stop-top' brake, Heavy duty wheel with Blickle Extrathane® polyurethane tread, with aluminium wheel centre

Product Data Sheet



Option:



RI-03.03

Directional lock