

# Product Data Sheet



## LK-ALTH 200K

EAN 4047526265878

ID 265876

**Pressed steel swivel castor, medium heavy duty brackets, with top plate fitting, Heavy duty wheel with Blickle Extrathane® polyurethane tread, with aluminium wheel centre**

### Bracket:

Made of heavy pressed steel, with double ball bearing in the swivel head, strong central kingpin, swivel head seals. The special Blickle dynamic riveting process of the swivel head results in minimal swivel head play and smooth rolling characteristics with an increased service life achieved by the work hardening of the ball race grooves. Bolted wheel axle. Zinc-plated, blue-passivated, Cr6-free.

### Wheels:

Made of high-quality, reaction-injected polyurethane-elastomer Blickle Extrathane®, low-noise operation, low rolling resistance, good floor preservation, very high abrasion resistance, high cut and tear propagation resistance, very good chemical connection with the wheel centre.

**Tread colours:** light brown

**Wheel centre/rim:** Made of die-cast aluminium. Casted tread.

**Wheel centre colour:** silver grey



### Rolling resistance

■■■■□ Very good

### Operating noise

■■■■□ Good













### Floor surface preservation

■■■■□ Good

# Product Data Sheet



## Technical data

|                           |   |              |
|---------------------------|---|--------------|
| Plate size                |  | 140 x 110    |
| Bolt hole spacing         |  | 105 x 75-80  |
| Bolt hole Ø               |  | 11           |
| Wheel Ø                   |  | 200 mm (D)   |
| Wheel width               |  | 50 mm (T2)   |
| Load capacity             |  | 600 kg       |
| Total height              |  | 245 mm (H)   |
| Offset swivel castor      |  | 65 mm        |
| unit weight               |  | 3,5 kg       |
| Temperature resistance to |  | -25 ° C      |
| Temperature resistance to |  | 70 ° C       |
| tread and tyre hardness   |   | 92° Shore A  |
| Bearing type              |  | Ball bearing |

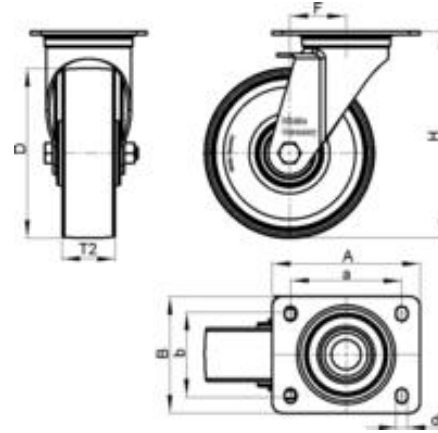

# Product Data Sheet



## Variants



### LK-ALTH 200K-AS

Pressed steel swivel castor, medium heavy duty brackets, with top plate fitting, Heavy duty wheel with Blickle Extrathane® polyurethane tread, with aluminium wheel centre



### LK-ALTH 200K-FI

Pressed steel swivel castor, medium heavy duty brackets, with top plate fitting and 'stop-fix' brake, Heavy duty wheel with Blickle Extrathane® polyurethane tread, with aluminium wheel centre



### LK-ALTH 200K-FI-AS

Pressed steel swivel castor, medium heavy duty brackets, with top plate fitting and 'stop-fix' brake, Heavy duty wheel with Blickle Extrathane® polyurethane tread, with aluminium wheel centre



### LK-ALTH 200K-IS

Pressed steel swivel castor, medium heavy duty brackets, with top plate fitting and 'ideal-stop' brake, Heavy duty wheel with Blickle Extrathane® polyurethane tread, with aluminium wheel centre



### LK-ALTH 200K-IS-AS

Pressed steel swivel castor, medium heavy duty brackets, with top plate fitting and 'ideal-stop' brake, Heavy duty wheel with Blickle Extrathane® polyurethane tread, with aluminium wheel centre



### LK-ALTH 200K-ST

Pressed steel swivel castor, medium heavy duty brackets, with top plate fitting and 'stop-top' brake, Heavy duty wheel with Blickle Extrathane® polyurethane tread, with aluminium wheel centre



### LK-ALTH 200K-ST-AS

Pressed steel swivel castor, medium heavy duty brackets, with top plate fitting and 'stop-top' brake, Heavy duty wheel with Blickle Extrathane® polyurethane tread, with aluminium wheel centre

## Option:



### RI-05.03

Directional lock