

Product Data Sheet



LH-ALTH 200K

EAN 4047526265946

ID 265942

Pressed steel swivel castor, heavy duty castors, with top plate fitting, Heavy duty wheel with Blickle Extrathane® polyurethane tread, with aluminium wheel centre

Bracket:

Made of heavy pressed steel, with heavy fork and top plate, very strong bolted and secured central kingpin, double ball bearing in the swivel head, additionally reinforced by the integration of four specially shaped and hardened bearing seats resulting in a very high resistance to shock and impact loads. Bolted wheel axle. Bolted wheel axle. Zinc-plated, blue-passivated, Cr6-free.

Wheels:

Made of high-quality, reaction-injected polyurethane-elastomer Blickle Extrathane®, low-noise operation, low rolling resistance, good floor preservation, very high abrasion resistance, high cut and tear propagation resistance, very good chemical connection with the wheel centre.

Tread colours: light brown

Wheel centre/rim: Made of die-cast aluminium. Casted tread.

Wheel centre colour: silver grey



Rolling resistance

■■■■□ Very good

Operating noise

■■■■□ Good













Floor surface preservation

■■■■□ Good

Product Data Sheet



Technical data

Plate size		140 x 110
Bolt hole spacing		105 x 75-80
Bolt hole Ø		11
Wheel Ø		200 mm (D)
Wheel width		50 mm (T2)
Load capacity		800 kg
Total height		245 mm (H)
Offset swivel castor		70 mm
unit weight		4,1 kg
Temperature resistance to		-25 ° C
Temperature resistance to		70 ° C
tread and tyre hardness		92° Shore A
Bearing type		Ball bearing

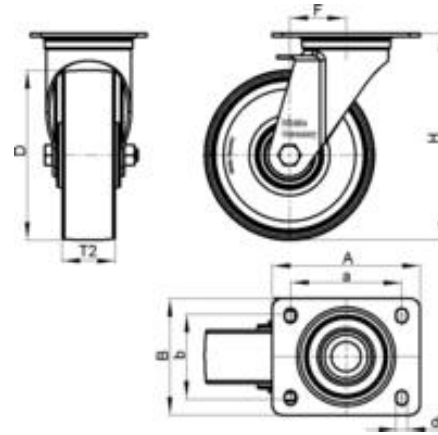

Product Data Sheet



Variants



LH-ALTH 200K-AS

Pressed steel swivel castor, heavy duty castors, with top plate fitting, Heavy duty wheel with Blickle Extrathane® polyurethane tread, with aluminium wheel centre



LH-ALTH 200K-CS13

Pressed steel swivel castor, heavy duty castors, with top plate fitting and central brake 'central-stop', Heavy duty wheel with Blickle Extrathane® polyurethane tread, with aluminium wheel centre



LH-ALTH 200K-CS13-AS

Pressed steel swivel castor, heavy duty castors, with top plate fitting and central brake 'central-stop', Heavy duty wheel with Blickle Extrathane® polyurethane tread, with aluminium wheel centre

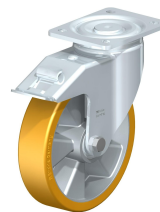

LH-ALTH 200K-FI

Pressed steel swivel castor, heavy duty castors, with top plate fitting and 'stop-fix' brake, Heavy duty wheel with Blickle Extrathane® polyurethane tread, with aluminium wheel centre



LH-ALTH 200K-FI-AS

Pressed steel swivel castor, heavy duty castors, with top plate fitting and 'stop-fix' brake, Heavy duty wheel with Blickle Extrathane® polyurethane tread, with aluminium wheel centre



LH-ALTH 200K-IS

Pressed steel swivel castor, heavy duty castors, with top plate fitting and 'ideal-stop' brake, Heavy duty wheel with Blickle Extrathane® polyurethane tread, with aluminium wheel centre



LH-ALTH 200K-IS-AS

Pressed steel swivel castor, heavy duty castors, with top plate fitting and 'ideal-stop' brake, Heavy duty wheel with Blickle Extrathane® polyurethane tread, with aluminium wheel centre



LH-ALTH 200K-ST

Pressed steel swivel castor, heavy duty castors, with top plate fitting and 'stop-top' brake, Heavy duty wheel with Blickle Extrathane® polyurethane tread, with aluminium wheel centre



LH-ALTH 200K-ST-AS

Pressed steel swivel castor, heavy duty castors, with top plate fitting and 'stop-top' brake, Heavy duty wheel with Blickle Extrathane® polyurethane tread, with aluminium wheel centre

Product Data Sheet



Option:



RI-05.03

Directional lock