

Product Data Sheet



LK-POTH 150K

EAN 4047526033071

ID 33076

Pressed steel swivel castor, medium heavy duty brackets, with top plate fitting, Wheel with thermoplastic polyurethane tread, with heavy nylon wheel centre, non-marking, non-staining

Bracket:

Made of heavy pressed steel, with double ball bearing in the swivel head, strong central kingpin, swivel head seals. The special Blickle dynamic riveting process of the swivel head results in minimal swivel head play and smooth rolling characteristics with an increased service life achieved by the work hardening of the ball race grooves. Bolted wheel axle. Zinc-plated, blue-passivated, Cr6-free.

Wheels:

Made of high-quality thermoplastic polyurethane, high operational comfort, low-noise operation, low rolling and swivelling resistance, good floor preservation, very high abrasion resistance, chemically bonded for an inseparable connection to the wheel centre.

Tread colours: dark grey

Wheel centre/rim: Made of high-quality, impact-resistant nylon.

Wheel centre colour: natural white

Variant: non-marking, non-staining



Rolling resistance

■■■■□ Very good

Operating noise

■■■■□ Good











Floor surface preservation

■■■■□ Good

Product Data Sheet



Technical data

Plate size		140 x 110
Bolt hole spacing		105 x 75-80
Bolt hole Ø		11
Wheel Ø		150 mm (D)
Wheel width		45 mm (T2)
Load capacity		500 kg
Total height		197 mm (H)
Offset swivel castor		63 mm
unit weight		2,6 kg
Temperature resistance to		-25 ° C
Temperature resistance to		70 ° C
tread and tyre hardness		94° Shore A
Bearing type		Ball bearing

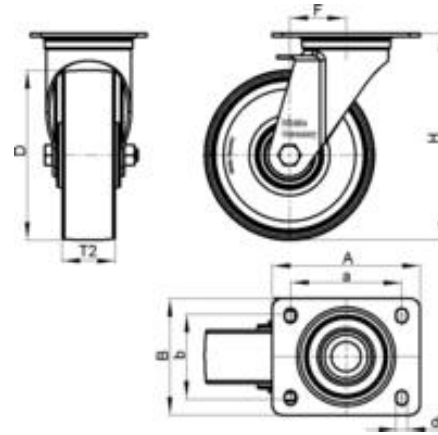

Product Data Sheet



Variants



LK-POTH 150K-FA

Pressed steel swivel castor, medium heavy duty brackets, with top plate fitting, Wheel with thermoplastic polyurethane tread, with heavy nylon wheel centre



LK-POTH 150K-FI

Pressed steel swivel castor, medium heavy duty brackets, with top plate fitting and 'stop-fix' brake, Wheel with thermoplastic polyurethane tread, with heavy nylon wheel centre



LK-POTH 150K-FI-FA

Pressed steel swivel castor, medium heavy duty brackets, with top plate fitting and 'stop-fix' brake, Wheel with thermoplastic polyurethane tread, with heavy nylon wheel centre



LK-POTH 150K-ST

Pressed steel swivel castor, medium heavy duty brackets, with top plate fitting and 'stop-top' brake, Wheel with thermoplastic polyurethane tread, with heavy nylon wheel centre



LK-POTH 150K-ST-FA

Pressed steel swivel castor, medium heavy duty brackets, with top plate fitting and 'stop-top' brake, Wheel with thermoplastic polyurethane tread, with heavy nylon wheel centre

Option:



RI-05.03

Directional lock