

Product Data Sheet



L-RD 200K

EAN 4047526042554

ID 42556

Pressed steel swivel castor, medium heavy duty brackets, with top plate fitting, Wheels with 'Blickle Comfort' two-component solid rubber tyres, with pressed steel rim

Bracket:

Made of heavy pressed steel, with double ball bearing in the swivel head, strong central kingpin, swivel head seals. The special Blickle dynamic riveting process of the swivel head results in minimal swivel head play and smooth rolling characteristics with an increased service life achieved by the work hardening of the ball race grooves. Bolted wheel axle. Zinc-plated, blue-passivated, Cr6-free.

Wheels:

Made of 'Blickle Comfort' two-component solid rubber, with hard rubber core and highly elastic rubber tread, very high operational comfort, low-noise operation, compared to standard solid rubber the operational comfort and the load capacity are increased whereas the rolling resistance is reduced, very good floor preservation.

Tread colours: black

Wheel centre/rim:

Pressed steel rim with tubular steel hub, pressed rim (special shock and impact-resistant design), zinc-plated, blue-passivated, Cr6-free. Tyre pressed with rim.

Wheel centre colour: blue passivated



Rolling resistance

■ ■ ■ □ □ Good

Operating noise

■ ■ ■ ■ □ Very good











Floor surface preservation

■ ■ ■ ■ □ Very good

Product Data Sheet



Technical data

Plate size		140 x 110
Bolt hole spacing		105 x 75-80
Bolt hole Ø		11
Wheel Ø		200 mm (D)
Tyre width		50 mm (T2)
Load capacity		350 kg
Total height		235 mm (H)
Offset swivel castor		65 mm
unit weight		3,5 kg
Temperature resistance to		-25 ° C
Temperature resistance to		80 ° C
tread and tyre hardness		65° Shore A
Bearing type		Ball bearing

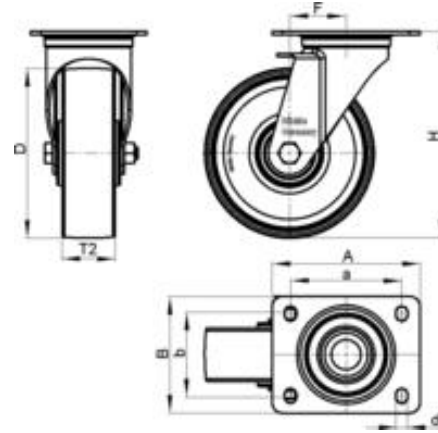

Product Data Sheet



Variants



L-RD 200K-CS11

Pressed steel swivel castor, medium heavy duty brackets, with top plate fitting and central brake 'central-stop', Wheels with 'Blickle Comfort' two-component solid rubber tyres, with pressed steel rim



L-RD 200K-CS11-FA

Pressed steel swivel castor, medium heavy duty brackets, with top plate fitting and central brake 'central-stop', Wheels with 'Blickle Comfort' two-component solid rubber tyres, with pressed steel rim



L-RD 200K-CS11-VLI

Pressed steel swivel castor, medium heavy duty brackets, with top plate fitting and central brake 'central-stop', Wheels with 'Blickle Comfort' two-component solid rubber tyres, with pressed steel rim



L-RD 200K-CS11-VLI-FA

Pressed steel swivel castor, medium heavy duty brackets, with top plate fitting and central brake 'central-stop', Wheels with 'Blickle Comfort' two-component solid rubber tyres, with pressed steel rim



L-RD 200K-FA

Pressed steel swivel castor, medium heavy duty brackets, with top plate fitting, Wheels with 'Blickle Comfort' two-component solid rubber tyres, with pressed steel rim



L-RD 200K-FI

Pressed steel swivel castor, medium heavy duty brackets, with top plate fitting and 'stop-fix' brake, Wheels with 'Blickle Comfort' two-component solid rubber tyres, with pressed steel rim



L-RD 200K-FI-FA

Pressed steel swivel castor, medium heavy duty brackets, with top plate fitting and 'stop-fix' brake, Wheels with 'Blickle Comfort' two-component solid rubber tyres, with pressed steel rim



L-RD 200K-FI-VLI

Pressed steel swivel castor, medium heavy duty brackets, with top plate fitting and 'stop-fix' brake, Wheels with 'Blickle Comfort' two-component solid rubber tyres, with pressed steel rim



L-RD 200K-FI-VLI-FA

Pressed steel swivel castor, medium heavy duty brackets, with top plate fitting and 'stop-fix' brake, Wheels with 'Blickle Comfort' two-component solid rubber tyres, with pressed steel rim



L-RD 200K-ST

Pressed steel swivel castor, medium heavy duty brackets, with top plate fitting and 'stop-top' brake, Wheels with 'Blickle Comfort' two-component solid rubber tyres, with pressed steel rim

Product Data Sheet



Variants



L-RD 200K-ST-FA

Pressed steel swivel castor, medium heavy duty brackets, with top plate fitting and 'stop-top' brake, Wheels with 'Blickle Comfort' two-component solid rubber tyres, with pressed steel rim



L-RD 200K-ST-VLI

Pressed steel swivel castor, medium heavy duty brackets, with top plate fitting and 'stop-top' brake, Wheels with 'Blickle Comfort' two-component solid rubber tyres, with pressed steel rim



L-RD 200K-ST-VLI-FA

Pressed steel swivel castor, medium heavy duty brackets, with top plate fitting and 'stop-top' brake, Wheels with 'Blickle Comfort' two-component solid rubber tyres, with pressed steel rim



L-RD 200K-VLI

Pressed steel swivel castor, medium heavy duty brackets, with top plate fitting, Wheels with 'Blickle Comfort' two-component solid rubber tyres, with pressed steel rim



L-RD 200K-VLI-FA

Pressed steel swivel castor, medium heavy duty brackets, with top plate fitting, Wheels with 'Blickle Comfort' two-component solid rubber tyres, with pressed steel rim

Option:



RI-05.03

Directional lock