

Product Data Sheet



LS-GSP0 125K

EAN 4047526048631

ID 48637

Welded steel heavy duty swivel castor, strong swivel head design, Heavy duty wheels made of cast nylon

Bracket:

Particularly rugged welded steel construction, with axial grooved ball bearing DIN 711 and tapered roller bearing DIN 720 in the swivel head, dust and splash-proof, fitted grease nipple, bolted and secured with a welded very strong central kingpin. Bolted wheel axle. Zinc-plated, yellow-passivated, Cr6-free.

Wheels:

Made of high-quality, impact-resistant, hard and tough, highly compressed cast nylon with outstanding load capacity, very low rolling and swivelling resistance, smooth running performance on even floors, very high abrasion resistance.

Tread colours: natural beige

Wheel centre/rim: - **Wheel centre colour:** natural beige



Rolling resistance

■■■■■ Excellent

Operating noise

■■□□□ Satisfactory





Floor surface preservation

■■□□□ Satisfactory

Product Data Sheet



Technical data

Plate size		140 x 110
Bolt hole spacing		105 x 75-80
Bolt hole Ø		11
Wheel Ø		125 mm (D)
Wheel width		55 mm (T2)
Load capacity		1750 kg
Total height		170 mm (H)
Offset swivel castor		50 mm
unit weight		4,1 kg
Temperature resistance to		-25 ° C
Temperature resistance to		80 ° C
tread and tyre hardness		80° Shore D
Bearing type		Ball bearing

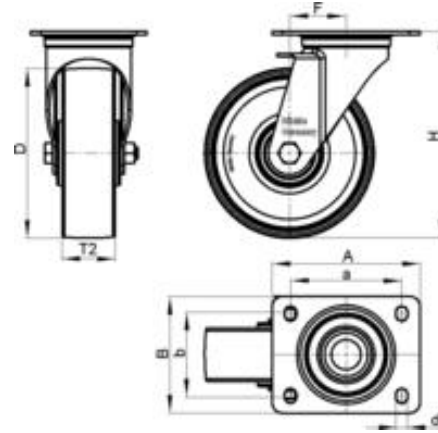

Product Data Sheet



Variants

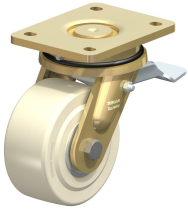

LS-GSP0 125K-ST

Welded steel extra heavy duty swivel castors, extra strong swivel head design, with 'stop-top' brake, Heavy duty wheels made of cast nylon



LS-GSP0 125K-RI2

Welded steel heavy duty swivel castor, strong swivel head design, Heavy duty wheels made of cast nylon



LS-GSP0 125K-RI4

Welded steel heavy duty swivel castor, strong swivel head design, Heavy duty wheels made of cast nylon

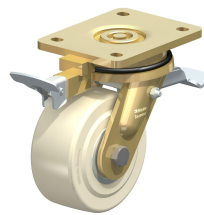

LS-GSP0 125K-ST-RI2

Welded steel extra heavy duty swivel castors, extra strong swivel head design, with 'stop-top' brake, Heavy duty wheels made of cast nylon



LS-GSP0 125K-ST-RI4

Welded steel extra heavy duty swivel castors, extra strong swivel head design, with 'stop-top' brake, Heavy duty wheels made of cast nylon