

Product Data Sheet



LH-SPO 127K

EAN 4047526524388

ID 524389

Pressed steel swivel castor, heavy duty castors, with top plate fitting, Heavy duty nylon wheel

Bracket:

Made of heavy pressed steel, with heavy fork and top plate, very strong bolted and secured central kingpin, double ball bearing in the swivel head, additionally reinforced by the integration of four specially shaped and hardened bearing seats resulting in a very high resistance to shock and impact loads. Bolted wheel axle. Bolted wheel axle. Zinc-plated, blue-passivated, Cr6-free.

Wheels:

Made of high-quality, impact-resistant nylon, very rugged, heavy wheel design, very low rolling and swivelling resistance, smooth running performance on even floors, very high abrasion resistance.

Tread colours: natural white

Wheel centre/rim: - Wheel centre colour: natural white



Rolling resistance

■■■■■ Excellent

Operating noise

■■□□□ Satisfactory













Floor surface preservation

■■□□□ Satisfactory

Product Data Sheet



Technical data

Plate size		140 x 110
Bolt hole spacing		105 x 75-80
Bolt hole Ø		11
Wheel Ø		125 mm (D)
Wheel width		50 mm (T2)
Load capacity		750 kg
Total height		170 mm (H)
Offset swivel castor		55 mm
unit weight		3,2 kg
Temperature resistance to		-25 ° C
Temperature resistance to		80 ° C
tread and tyre hardness		70° Shore D
Bearing type		Ball bearing

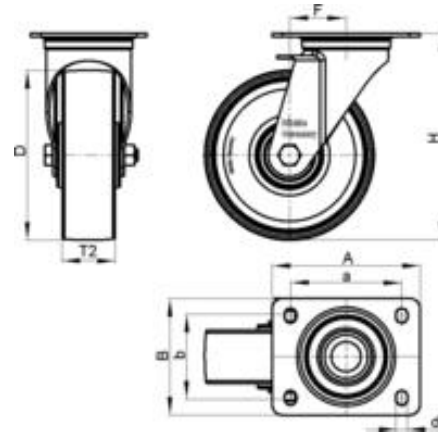

Product Data Sheet



Variants



LH-SPO 127K-CS13

Pressed steel swivel castor, heavy duty castors, with top plate fitting and central brake 'central-stop', Heavy duty nylon wheel



LH-SPO 127K-CS13-FA

Pressed steel swivel castor, heavy duty castors, with top plate fitting and central brake 'central-stop', Heavy duty nylon wheel



LH-SPO 127K-FA

Pressed steel swivel castor, heavy duty castors, with top plate fitting, Heavy duty nylon wheel



LH-SPO 127K-FI

Pressed steel swivel castor, heavy duty castors, with top plate fitting and 'stop-fix' brake, Heavy duty nylon wheel



LH-SPO 127K-FI-FA

Pressed steel swivel castor, heavy duty castors, with top plate fitting and 'stop-fix' brake, Heavy duty nylon wheel



LH-SPO 127K-IS

Pressed steel swivel castor, heavy duty castors, with top plate fitting and 'ideal-stop' brake, Heavy duty nylon wheel



LH-SPO 127K-IS-FA

Pressed steel swivel castor, heavy duty castors, with top plate fitting and 'ideal-stop' brake, Heavy duty nylon wheel



LH-SPO 127K-ST

Pressed steel swivel castor, heavy duty castors, with top plate fitting and 'stop-top' brake, Heavy duty nylon wheel



LH-SPO 127K-ST-FA

Pressed steel swivel castor, heavy duty castors, with top plate fitting and 'stop-top' brake, Heavy duty nylon wheel

Product Data Sheet



Option:



RI-05.03

Directional lock