

# Product Data Sheet



## LS-SVS 201K

EAN 4047526614010

ID 614016

**Welded steel heavy duty swivel castor, strong swivel head design, Extra heavy duty solid steel wheel**

### Bracket:

Particularly rugged welded steel construction, with axial grooved ball bearing DIN 711 and tapered roller bearing DIN 720 in the swivel head, dust and splash-proof, fitted grease nipple, bolted and secured with a welded very strong central kingpin. Bolted wheel axle. Zinc-plated, yellow-passivated, Cr6-free.

### Wheels:

Made of mild steel, with slightly crowned tread and lightly oiled surface, very low rolling and swivelling resistance, smooth running performance on even floors, extremely wear-resistant, particularly high static and dynamic load capacity.

**Tread colours:** silver

**Wheel centre/rim: - Wheel centre colour:** silver



### Rolling resistance

■■■■■ Excellent

### Operating noise

■□□□□ Sufficient













### Floor surface preservation

■□□□□ Sufficient

# Product Data Sheet



## Technical data

|                           |   |              |
|---------------------------|---|--------------|
| Plate size                |  | 175 x 140    |
| Bolt hole spacing         |  | 140 x 105    |
| Bolt hole Ø               |  | 14           |
| Wheel Ø                   |  | 200 mm (D)   |
| Wheel width               |  | 55 mm (T2)   |
| Load capacity             |  | 3000 kg      |
| Total height              |  | 255 mm (H)   |
| Offset swivel castor      |  | 65 mm        |
| unit weight               |  | 18,9 kg      |
| Temperature resistance to |  | -25 ° C      |
| Temperature resistance to |  | 120 ° C      |
| tread and tyre hardness   |   | 190 - 230 HB |
| Bearing type              |  | Ball bearing |

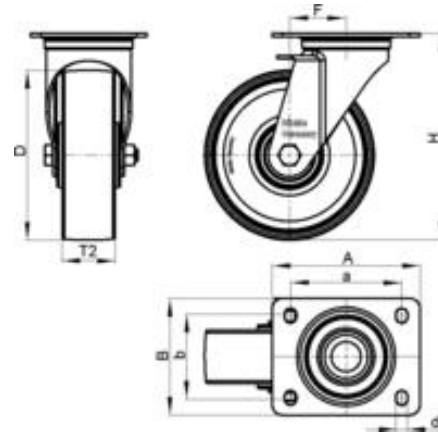

# Product Data Sheet



## Variants

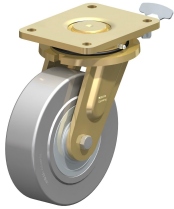

### LS-SVS 201K-RI2

Welded steel heavy duty swivel castor, strong swivel head design, Extra heavy duty solid steel wheel



### LS-SVS 201K-RI4

Welded steel heavy duty swivel castor, strong swivel head design, Extra heavy duty solid steel wheel