

Product Data Sheet



LH-GB 160K-FI

EAN 4047526021016

ID 742236

Pressed steel swivel castor, heavy duty castors, with top plate fitting and 'stop-fix' brake, Heavy duty wheel with Blickle Besthane® polyurethane tread, with cast iron wheel centre

Bracket:

Made of heavy pressed steel, with heavy fork and top plate, very strong bolted and secured central kingpin, double ball bearing in the swivel head, additionally reinforced by the integration of four specially shaped and hardened bearing seats resulting in a very high resistance to shock and impact loads. Bolted wheel axle. Bolted wheel axle. Zinc-plated, blue-passivated, Cr6-free.

Wheels:

Made of high-quality, reaction-injected polyurethane-elastomer Blickle Besthane®, low-noise operation, very low rolling resistance, high dynamic load capacity, good floor preservation, very high abrasion resistance, high cut and tear propagation resistance, very good chemical connection with the wheel centre.

Tread colours: brown

Wheel centre/rim:

Made of grey cast iron, with grease nipple, lacquered. Casted tread.

Wheel centre colour: silver

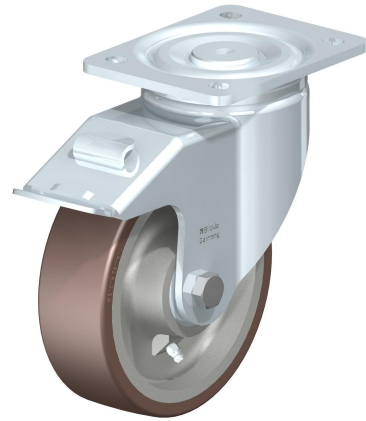

Rolling resistance

■■■■■ Excellent

Operating noise

■■■■□ Good











Floor surface preservation

■■■■□ Good

Product Data Sheet



Technical data

Plate size		140 x 110
Bolt hole spacing		105 x 75-80
Bolt hole Ø		11
Wheel Ø		160 mm (D)
Wheel width		50 mm (T2)
Load capacity		800 kg
Total height		202 mm (H)
Offset swivel castor		65 mm
unit weight		6,1 kg
Temperature resistance to		-25 ° C
Temperature resistance to		70 ° C
tread and tyre hardness		92° Shore A
Bearing type		Ball bearing

