

Product Data Sheet



LIK-G 125G-1

EAN 4047526102081

ID 754684

Heat-resistant pressed steel swivel castor with top plate fitting, Cast iron wheel

Bracket:

Made of pressed steel, with double ball bearing in the swivel head, with heat resistant swivel head seals. The special Blickle dynamic riveting process of the swivel head results in smooth rolling characteristics, increased service life and the swivel head play is set specifically for high temperature applications, with special heat-resistant grease. Bolted wheel axle. Zinc-plated, blue-passivated, Cr6-free.

Wheels:

Made of rugged grey cast iron, machined tread and tread edges, with grease nipple, exceptionally low rolling and swivel resistance, outstanding wear resistance, lacquered.

Tread colours: silver grey

Wheel centre/rim: - Wheel centre colour: silver grey



Rolling resistance

■ ■ ■ ■ ■ Excellent

Operating noise

■ □ □ □ □ Sufficient











Floor surface preservation

■ □ □ □ □ Sufficient

Product Data Sheet



Technical data

Plate size		100 x 85
Bolt hole spacing		80 x 60
Bolt hole Ø		9
Wheel Ø		125 mm (D)
Wheel width		35 mm (T2)
Load capacity		350 kg
Total height		155 mm (H)
Offset swivel castor		48 mm
unit weight		2,4 kg
Temperature resistance to		-30 ° C
Temperature resistance to		270 ° C
tread and tyre hardness		180 - 220 HB
Bearing type		Plain bore

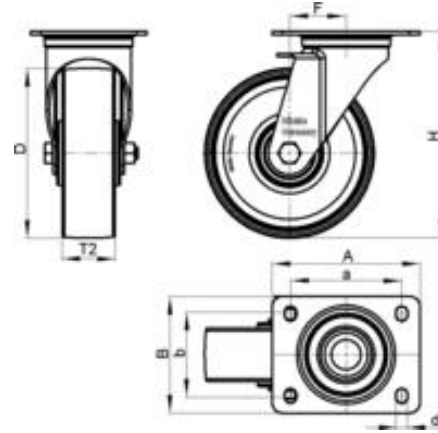

Product Data Sheet



Variants



LIK-G 125G-1-FI

Heat-resistant pressed steel swivel castor with top plate fitting and 'stop-fix' brake, Cast iron wheel