

# Product Data Sheet



## LS-GB 154K

EAN 4047526099787

ID 755032

**Welded steel heavy duty swivel castor, strong swivel head design, Heavy duty wheel with Blickle Besthane® polyurethane tread, with cast iron wheel centre**

### Bracket:

Particularly rugged welded steel construction, with axial grooved ball bearing DIN 711 and tapered roller bearing DIN 720 in the swivel head, dust and splash-proof, fitted grease nipple, bolted and secured with a welded very strong central kingpin. Bolted wheel axle. Zinc-plated, yellow-passivated, Cr6-free.

### Wheels:

Made of high-quality, reaction-injected polyurethane-elastomer Blickle Besthane®, low-noise operation, very low rolling resistance, high dynamic load capacity, good floor preservation, very high abrasion resistance, high cut and tear propagation resistance, very good chemical connection with the wheel centre.

**Tread colours:** brown

**Wheel centre/rim:** Made of grey cast iron, lacquered. Casted tread.

**Wheel centre colour:** silver

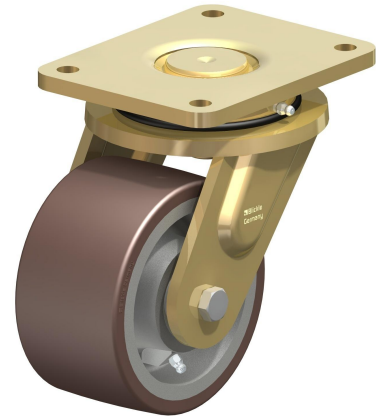

### Rolling resistance

■■■■■ Excellent

### Operating noise

■■■■□ Good













### Floor surface preservation

■■■■□ Good

# Product Data Sheet



## Technical data

Plate size		175 x 140
Bolt hole spacing		140 x 105
Bolt hole Ø		14
Wheel Ø		150 mm (D)
Wheel width		80 mm (T2)
Load capacity		1050 kg
Total height		205 mm (H)
Offset swivel castor		65 mm
unit weight		kg
Temperature resistance to		-25 ° C
Temperature resistance to		70 ° C
tread and tyre hardness		92° Shore A
Bearing type		Ball bearing

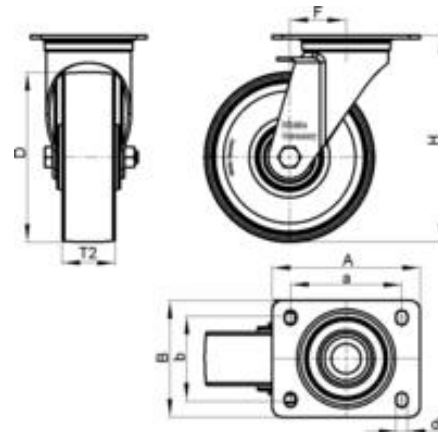

# Product Data Sheet



## Variants

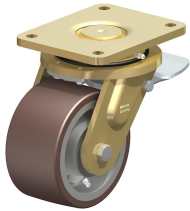

### LS-GB 154K-ST

Welded steel heavy duty swivel castor, strong swivel head design, with 'stop-top' brake, Heavy duty wheel with Blickle Besthane® polyurethane tread, with cast iron wheel centre

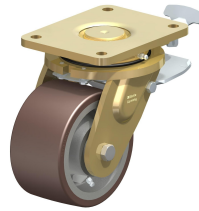

### LS-GB 154K-ST-RI2

Welded steel heavy duty swivel castor, strong swivel head design, with 'stop-top' brake, Heavy duty wheel with Blickle Besthane® polyurethane tread, with cast iron wheel centre

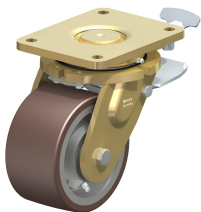

### LS-GB 154K-ST-RI4

Welded steel heavy duty swivel castor, strong swivel head design, with 'stop-top' brake, Heavy duty wheel with Blickle Besthane® polyurethane tread, with cast iron wheel centre



### LS-GB 154K-RI2

Welded steel heavy duty swivel castor, strong swivel head design, Heavy duty wheel with Blickle Besthane® polyurethane tread, with cast iron wheel centre

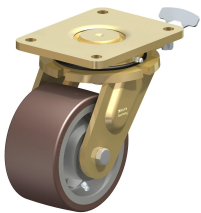

### LS-GB 154K-RI4

Welded steel heavy duty swivel castor, strong swivel head design, Heavy duty wheel with Blickle Besthane® polyurethane tread, with cast iron wheel centre