

# Product Data Sheet



## LRA-PATH 50G

EAN 4047526075576

ID 755977

**Light duty swivel castor with bolt hole fitting, Wheel with thermoplastic polyurethane tread, with nylon wheel centre**

### Bracket:

Made of pressed steel, with double ball bearing in the swivel head, strong central kingpin, ball protection by the special top plate and ball disc design. The special Blickle dynamic riveting process of the swivel head results in minimal swivel head play and smooth rolling characteristics with an increased service life achieved by the work hardening of the ball race grooves. Bolted wheel axle. Zinc-plated, blue-passivated, Cr6-free.

### Wheels:

Made of high-quality thermoplastic polyurethane, low-noise operation, low rolling and swivelling resistance, good floor preservation, very high abrasion resistance, chemically bonded for an inseparable connection to the wheel centre.

**Tread colours:** dark grey

### Wheel centre/rim:

Made of high-quality, impact-resistant nylon. Chemically bonded.

**Wheel centre colour:** grey



### Rolling resistance

■ ■ ■ ■ □ Very good

### Operating noise

■ ■ ■ □ □ Good











### Floor surface preservation

■ ■ ■ □ □ Good

# Product Data Sheet



## Technical data

Plate size		43
Bolt hole Ø		11
Wheel Ø		50 mm (D)
Wheel width		19 mm (T2)
Load capacity		75 kg
Total height		69 mm (H)
Offset swivel castor		23 mm
unit weight		0,2 kg
Temperature resistance to		-25 ° C
Temperature resistance to		70 ° C
tread and tyre hardness		94° Shore A
Bearing type		Plain bore

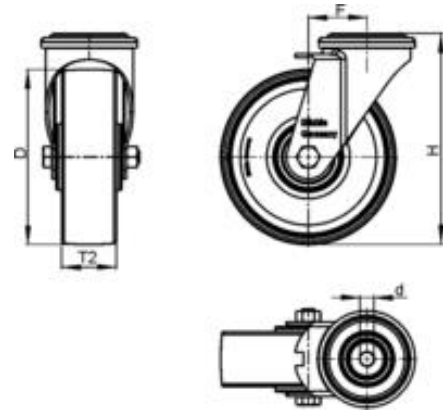

# Product Data Sheet



## Variants



### LRA-PATH 50G-FI

Light duty swivel castor with bolt hole fitting with synthetic brake lever, Wheel with thermoplastic polyurethane tread, with nylon wheel centre



### LRA-PATH 50G-FI-E01

Wheel with thermoplastic polyurethane tread, with nylon wheel centre



### LRA-PATH 50G-FI-E02

Wheel with thermoplastic polyurethane tread, with nylon wheel centre



### LRA-PATH 50G-FI-E03

Wheel with thermoplastic polyurethane tread, with nylon wheel centre



### LRA-PATH 50G-FI-E04

Wheel with thermoplastic polyurethane tread, with nylon wheel centre



### LRA-PATH 50G-FI-E05

Wheel with thermoplastic polyurethane tread, with nylon wheel centre



### LRA-PATH 50G-FI-E07

Wheel with thermoplastic polyurethane tread, with nylon wheel centre



### LRA-PATH 50G-FI-ER02

Wheel with thermoplastic polyurethane tread, with nylon wheel centre



### LRA-PATH 50G-FI-ER03

Wheel with thermoplastic polyurethane tread, with nylon wheel centre



### LRA-PATH 50G-FI-ER04

Wheel with thermoplastic polyurethane tread, with nylon wheel centre

# Product Data Sheet



## Variants



### LRA-PATH 50G-FI-ER05

Wheel with thermoplastic polyurethane tread, with nylon wheel centre



### LRA-PATH 50G-FI-ES

Light duty swivel castor, with plug-in pin, with 'stop-fix' brake and synthetic brake lever, Wheel with thermoplastic polyurethane tread, with nylon wheel centre



### LRA-PATH 50G-FI-EV02

Wheel with thermoplastic polyurethane tread, with nylon wheel centre



### LRA-PATH 50G-FI-EV03

Wheel with thermoplastic polyurethane tread, with nylon wheel centre



### LRA-PATH 50G-FI-EV04

Wheel with thermoplastic polyurethane tread, with nylon wheel centre



### LRA-PATH 50G-FI-EV05

Wheel with thermoplastic polyurethane tread, with nylon wheel centre



### LRA-PATH 50G-FI-EV07

Wheel with thermoplastic polyurethane tread, with nylon wheel centre



### LRA-PATH 50G-FI-GS10

Light duty swivel castor, with zinc-plated steel threaded pin, with 'stop-fix' brake and synthetic brake lever, Wheel with thermoplastic polyurethane tread, with nylon wheel centre



### LRA-PATH 50G-E01

Light duty swivel castor with expander, Wheel with thermoplastic polyurethane tread, with nylon wheel centre



### LRA-PATH 50G-E02

Light duty swivel castor with expander, Wheel with thermoplastic polyurethane tread, with nylon wheel centre

# Product Data Sheet



## Variants



### LRA-PATH 50G-E03

Light duty swivel castor with expander,  
Wheel with thermoplastic polyurethane  
tread, with nylon wheel centre



### LRA-PATH 50G-E04

Light duty swivel castor with expander,  
Wheel with thermoplastic polyurethane  
tread, with nylon wheel centre



### LRA-PATH 50G-E05

Light duty swivel castor with expander,  
Wheel with thermoplastic polyurethane  
tread, with nylon wheel centre

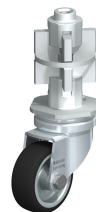

### LRA-PATH 50G-E07

Light duty swivel castor with expander,  
Wheel with thermoplastic polyurethane  
tread, with nylon wheel centre



### LRA-PATH 50G-ER02

Light duty swivel castor with expander,  
Wheel with thermoplastic polyurethane  
tread, with nylon wheel centre



### LRA-PATH 50G-ER03

Light duty swivel castor with expander,  
Wheel with thermoplastic polyurethane  
tread, with nylon wheel centre



### LRA-PATH 50G-ER04

Light duty swivel castor with expander,  
Wheel with thermoplastic polyurethane  
tread, with nylon wheel centre



### LRA-PATH 50G-ER05

Light duty swivel castor with expander,  
Wheel with thermoplastic polyurethane  
tread, with nylon wheel centre



### LRA-PATH 50G-ES

Light duty swivel castor with plug-in pin,  
Wheel with thermoplastic polyurethane  
tread, with nylon wheel centre



### LRA-PATH 50G-EV02

Light duty swivel castor with expander,  
Wheel with thermoplastic polyurethane  
tread, with nylon wheel centre

# Product Data Sheet



## Variants



### LRA-PATH 50G-EV03

Light duty swivel castor with expander,  
Wheel with thermoplastic polyurethane  
tread, with nylon wheel centre



### LRA-PATH 50G-EV04

Light duty swivel castor with expander,  
Wheel with thermoplastic polyurethane  
tread, with nylon wheel centre



### LRA-PATH 50G-EV05

Light duty swivel castor with expander,  
Wheel with thermoplastic polyurethane  
tread, with nylon wheel centre



### LRA-PATH 50G-EV07

Light duty swivel castor with expander,  
Wheel with thermoplastic polyurethane  
tread, with nylon wheel centre



### LRA-PATH 50G-GS10

Light duty swivel castor with threaded  
pin, Wheel with thermoplastic  
polyurethane tread, with nylon wheel  
centre